

**Humidity / Temperature transmitter
TH 300**

- Ranges from 0-100%RH and -40 to +180°C (probe dependent)
- Configurable ranges
- Functions : relative and absolute humidity, dew point, wet and dry temperature, enthalpy.
- Smart-Pro interchangeable probes (PC or stainless steel)
- On-site calibration
- Simultaneous display of 1 to 4 parameters
- External transmitter inputs (KIMO Class 200 and 300)
- 2 outputs 4-20 mA (4 wires) or 0-10V, RS 232, 2 RCR relays 6A/230 Vac
- 2 visual alarms (dual color LED) and audible alarm (buzzer - 80 dB)
- Output diagnostics
- MODBUS network RS 485 system (optional)
- ABS or ALU IP 65 housing, with or without backlit graphic display.
- Quick and easy mounting using "1/4 turn" system with wall-mounting plate.



Transmitter features

Humidity

- Measuring range0 to 100 % RH
- Units of measurement% RH
- Accuracy*(Repeatability, linearity, hysteresis)±1,5%RH (from 3 to 98%RH and if 15°C≤T≤25°C)
- Temperature dependence±0.04 x IT-201%RH (if T<15°C or T>25°C)
- Response time<10 sec. (from 10% RH to 80%RH, V_{air}=2m/s)
- Resolution0,1 % RH
- Factory calibration uncertainty±0.88%RH
- Type of sensorcapacitive
- Type of fluidair and neutral gases (high resistance to solvents)

Temperature

- Measuring range**from -20 to +120°C (polycarbonate probe)
.....from -40 to +180°C (stainless steel probe)
- Units of measurement°C, °F
- Accuracy *±0,3% of reading ±0,25°C
- Response timet_{0,9} = 9 sec. for V_{air} = 1 m/s
- Resolution0,1°C
- Type of sensor.....Pt 100 1/3 selon DIN IEC 751
- Type of fluid.....air and neutral gases

**Analogue output is configured by default at our factory, from 0 to 50°C.
See « Configuration » part to configure analogue outputs.

* All accuracies indicated in this technical datasheet were stated in laboratory conditions, and can be guaranteed for measurements carried out in the same conditions, or carried out with calibration compensation.
As per NFX 15-113 and the Charter 2000/2001 HYGROMETERS, GAL (Guaranteed Accuracy Limit) which has been calculated with a coverage factor value of 2 is ±2.58%RH between 18 and 28°C on the measuring range from 3 to 98%RH. Sensor drift is less than 1%RH/year.

Functions

Class 300 transmitters have 2 analogue outputs which correspond to the first 2 parameters displayed. You can activate 1 or 2 outputs, and for each output, you can choose between humidity, temperature and the functions below :

| Features Functions | Measuring ranges | Units and resolutions |
|-----------------------|------------------------|-----------------------|
| Mixing ratio | from 2 to 900 g/Kg | 0,1 g/kg |
| Dew point | from -80 to +180°C | 0,1 °C |
| Wet temperature | from -20 to +180°C | 0,1°C |
| Enthalpy | from 0 to 15 000 Kj/Kg | 0,1 Kj/Kg |

Class 300 transmitters can display up to 4 parameters simultaneously. The last 2 parameters are only displayed, they have no output.

Part number

To order, just add the codes to complete the part number :

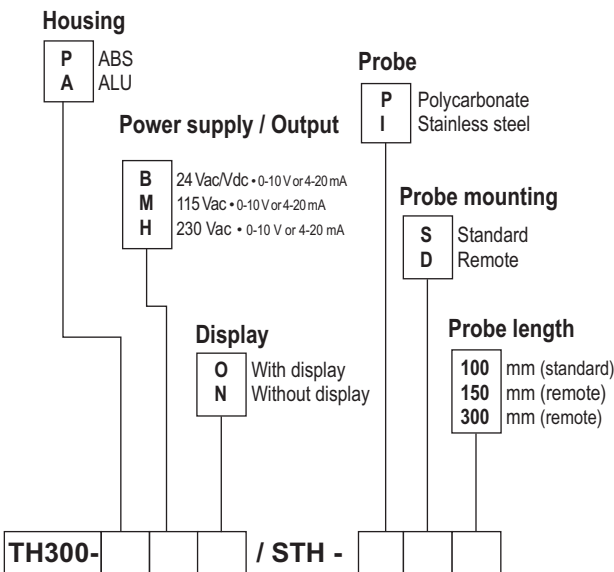

Example : TH300-PBN/STH-PD300 = humidity transmitter type TH300, with ABS housing, 24 Vac/Vdc power supply, without display, with polycarbonate remote probe length 300mm.



- Easy maintenance with the new **SMART PRO digital probes**.
- **Totally interchangeable:** they are individually adjusted and are automatically recognized by the transmitter.

Housing dimensions

(including wall-mounting plate)

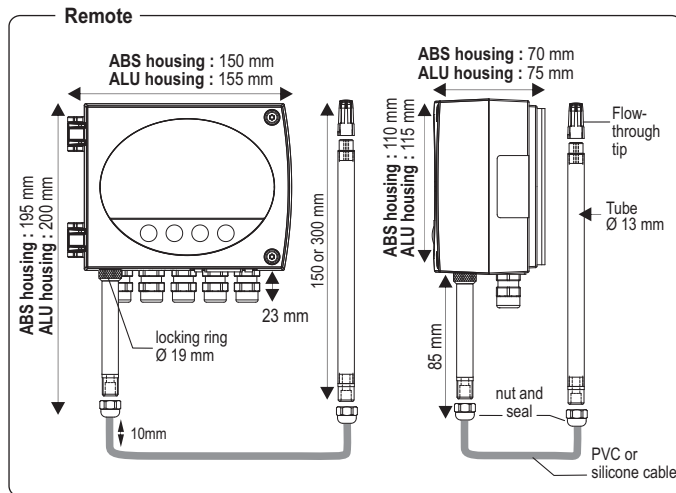
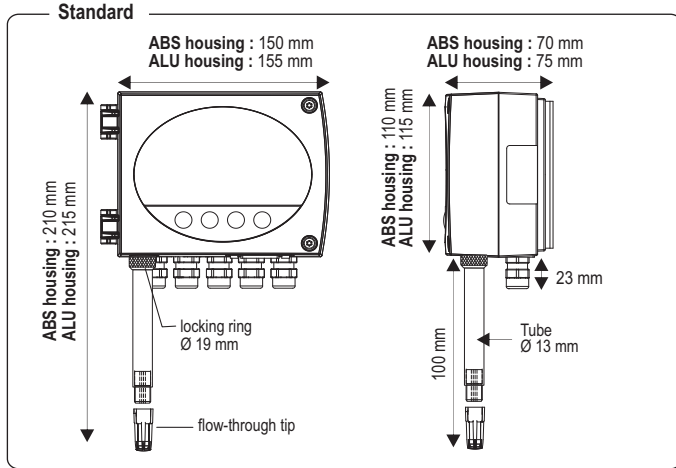

Housing features

- Housing**ALU or ABS
Fire-proof classification.....ABS : V 0 as per UL94
Dimensionssee drawing above
Protection.....IP65
Displaygraphic from 1 to 4-line digital and backlit display
 70 mm x 38 mm
 protection screen made of PMMA
Connection fittingsALU : nickel plated brass for cables 9mm max.
 ABS : polyamide for cables 7 mm max.
WeightABS : 800 g - ALU : 1300 g

Relays and Alarms

- Class 300 transmitters have 4 stand-alone and configurable alarms :
 2 visual alarms (dual color LED) and 2 relays (contacts).
You can set :
- the parameter (pressure, air velocity, temperature)
 - 1 or 2 set points (high and low) for each alarm
 - the time-delay / 60 sec max.
 - the alarm action (rising or falling)
 - the relay operation mode : positive or negative security
 - the audible alarm (buzzer) activation.

Probes features

Polycarbonate probes

- Measuring range**.....-20 to +120°C
Standard probe.....Length 100 mm
Remote probeLength 150 or 300 mm
CablePVC Ø 4,8 mm, lg 2 m

Polycarbonate probes are supplied with a protection flow-through tip made of polycarbonate with stainless steel filter 25 (ref.EPP2).

Stainless steel probes

- Measuring range**.....-40 to +180°C
Standard probe.....Length 100 mm
Remote probeLength 150 or 300 mm
Cablesilicone Ø 4,8 mm, lg 2 m

Stainless steel probes are supplied with a protection flow-through tip made of stainless steel filter 25 (ref.EPI25).

Tip selection

| Part number | EPP2 | EPI25 | EPI100 | EPFI | EPFT |
|---------------------------|-------------------|--------------------------|--------------------------|--------------------------|---------------------|
| Specifications | | | | | |
| Tip material | PC ⁽¹⁾ | St. steel ⁽³⁾ | St. steel ⁽³⁾ | St. steel ⁽³⁾ | PTFE ⁽²⁾ |
| Filter material | St. steel meshed | St. steel meshed | St. steel meshed | St. steel sintered | PTFE sintered |
| Filter type | 25 | 25 | 100 | 10 | 50 |
| Maximum particles | 25m/s | 25m/s | 20m/s | 30m/s | 25m/s |
| Maximum air velocity | 120°C | 180°C | 120°C | 180°C | 180°C |
| Maximum temperature | 95%RH | 95%RH | 100%RH | 90%RH | 90%RH |
| Maximum relative humidity | 30mm | 30mm | 30mm | 30mm | 30mm |
| Length | | | | | |

Applications

| | | | | | |
|------------------------------|-----|-----|-----|-----|-----|
| HVAC air-conditioning system | yes | yes | | | |
| Cold storage room | | | yes | | yes |
| Industry | yes | yes | yes | yes | yes |
| Pharma plants / Electronics | yes | yes | yes | yes | yes |
| Dryer | | | | yes | yes |
| Curing | | | | yes | |
| Swimming-pool | | | yes | | yes |

Harsh environments

| | | | | | |
|-------------------|--|-----|-----|-----|-----|
| Water droplets | | | | | yes |
| Shavings/cuttings | | yes | | yes | |
| Dust | | | yes | | |
| Chemical products | | | | | yes |
| Grease | | | | | yes |

(1) PC : Polycarbonate - (2) PTFE : Teflon® - (3) St. steel: 316 L

Technical Specifications

- Power supply**.....24 Vac / Vdc ±10%
 115 Vac or 230 Vac ±10%, 50-60 Hz
Output2 x 4-20 mA or 2 x 0-10 V (4 wires)
 maximum load : 500 Ohms (4-20 mA)
 minimum load : 1 K Ohms (0-10 V)
Galvanic isolationinputs and outputs (115 Vac/230 Vac models)
 outputs (24 Vac/Vdc models)
Consumption.....5 VA
Relays2 RCR relays 6A / 230 Vac
Visual alarms2 dual color LED
Audible alarmbuzzer
Electro-magnetical compatibility...EN 61 326
Electrical connection.....screw terminal block for cables Ø 1.5 mm² max
RS 485 communication.....Digital : RTU Modbus protocol
 communication speed configurable
 from 2400 to 115200 Bauds
RS 232 communication.....Digital : ASCII, proprietary protocol
Working temperature(housing)0 to +50°C
Working temperature(probe).....-20 to +120°C (polycarbonate)
 -40 to +180°C (stainless steel)
Storage temperature-10 to +70°C
Environmentair and neutral gases

Connection

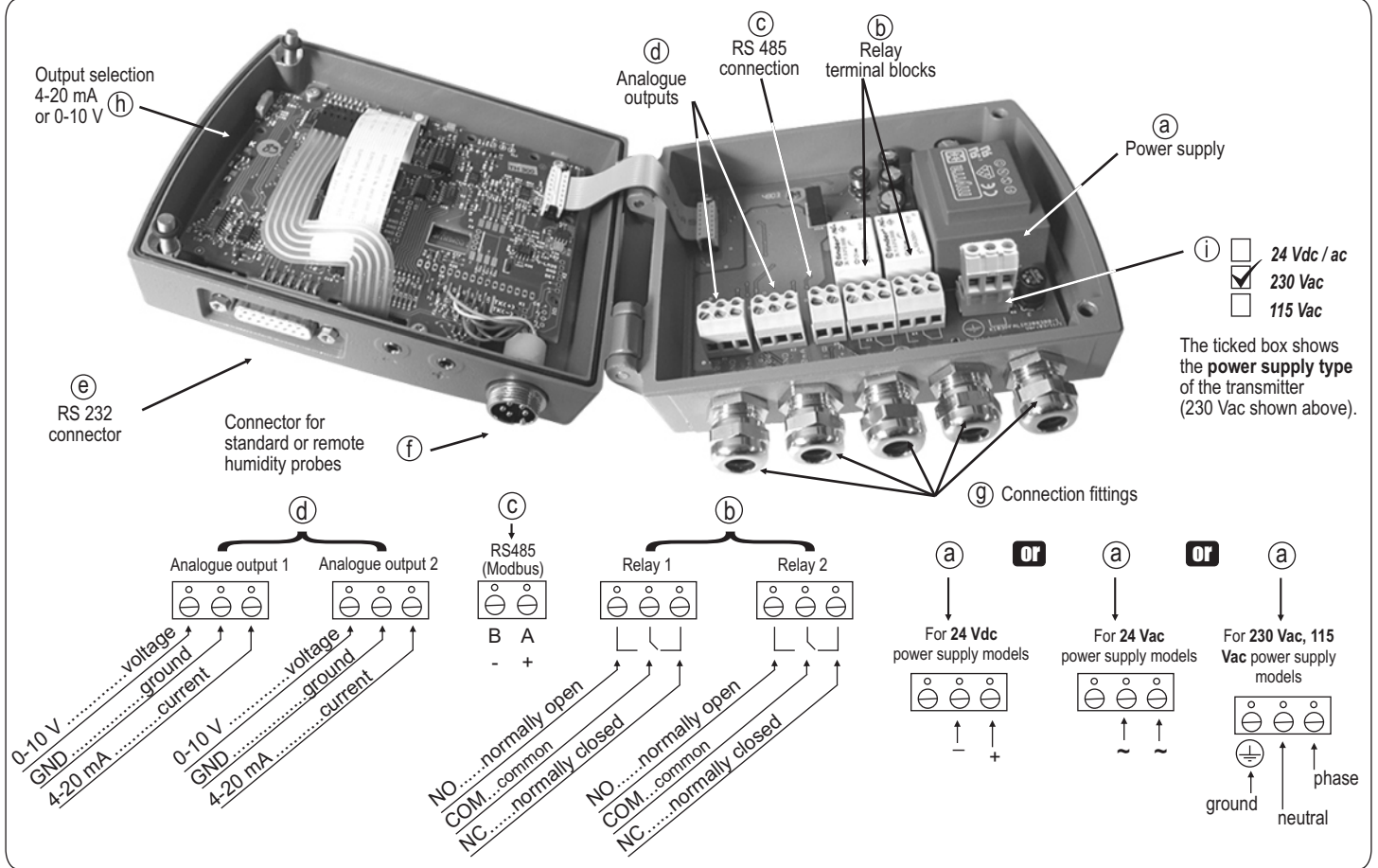

Electrical connections - as per NFC15-100 norm

⚠ This connection must be made by a qualified technician. Whilst making the connection, the transmitter must not be energized.

Power supply connection :

⚠ Before making the connection, you must first check the power supply which is indicated on the transmitter board (see (i) on the connection drawing).

• For 24 Vdc power supply models :

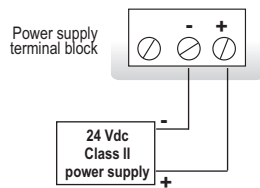

• For 24 Vac power supply models :

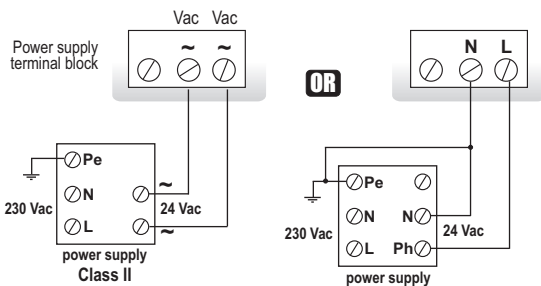

• For 115 or 230 Vac power supply models :

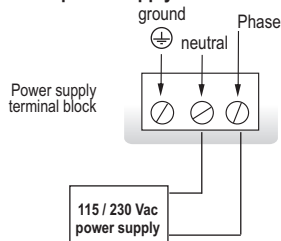

Output signal selection voltage (0-10 V) or current (4-20 mA)

The on-off switch located on the left top of the transmitter (see (d) on connection drawing) allows selection of the required outputs.

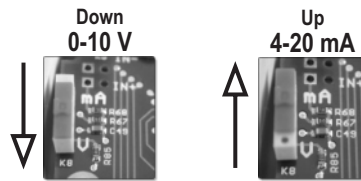

Output connection :

• 4-20 mA current output :

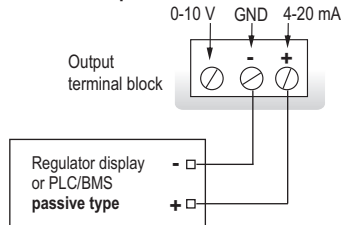

• 0-10 V voltage output :

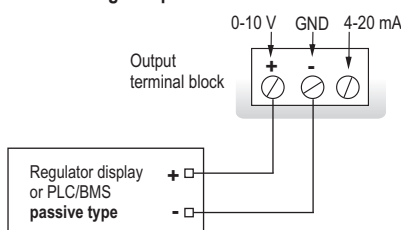

Connection of SUB-D15 RS232 and RS 485 (Modbus) (see (e) on connection drawing)

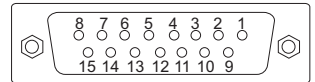

| Pin # | Description |
|-------|--------------|
| 1 | NC * |
| 2 | NC * |
| 3 | NC * |
| 4 | B - (RS485) |
| 5 | A + (RS485) |
| 6 | NC * |
| 7 | NC * |
| 8 | NC * |
| 9 | RX (RS 232) |
| 10 | NC * |
| 11 | TX (RS 232) |
| 12 | NC * |
| 13 | NC * |
| 14 | NC * |
| 15 | GND (RS 232) |

⚠ CAUTION :
NC * --> DO NOT CONNECT

Digital communication

RS 232 communication

- Via the RS 232 connection, TH 300 can display 1 or 2 parameters that are measured by others KIMO Class 200 and 300 transmitters. Benefit : the TH 300 can display (in addition to the humidity and temperature) other parameters such as pressure, air velocity or airflow from a CP200 for example.
- Via the RS 232 connection, you can also configure your transmitter with the LCC-300 software.
- The RS 232 connection cable is available in 2 m, 5 m or 10 m (maximum) lengths.



Modbus network (RS 485 system)

- Class 300 transmitters can be linked in one network, on a RS 485 home bus. They can also be integrated into an existing network.
- When a Class 200 or 300 transmitters is connected to a TH 300 (with RS 232 connection), all the measurements can be given to the PLC/BMS via the RS 485, with only one address for the 2 transmitters.
- The RS 485 digital communication is a 2-wire network, on which the transmitters are connected in parallel. They are connected to a PLC/BMS via the RTU Modbus communication system. Since we can configure the TH 300 with the keypad, the MODBUS enables to configure at distance, to measure 1 or 2 parameters, to see the status of the alarms...

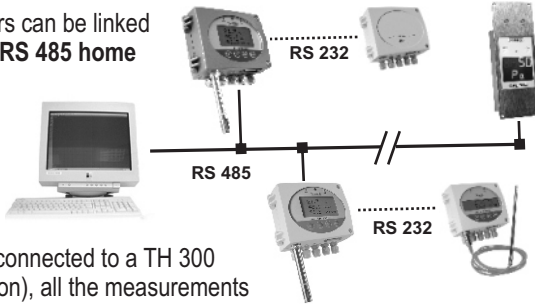

Configuration

You can configure all the parameters of the transmitter : **units, measuring ranges, alarms, outputs, channels, calculation formula....** via the different methods shown below.

- **Via keypad** : only on models with display
A code-locking system combined with keypad guarantees the security of the installation. See configuration manual.
- **Via remote control** (optional) : only on models with display
This is convenient to configure the transmitters located far from the user or hard to reach. Same way as with a keypad.
- **Via software** (optional) : on all models.
Simple and user-friendly configuration. See LCC-300 user manual.
- **Via MODBUS** (optional) : on all models.
Configuration of all parameters from your PC, via the supervision or data acquisition software.

Configurable analogue outputs

Configure the range according to your needs : outputs are automatically adjusted to the new measuring range.

Range with centre zero (-40/0/+40°C), with offset zero (-30/0/70°C), or standard range (0/100 °C) => you can configure your own intermediate ranges according to your needs, between 10% and 100% of the full scale.

The minimum configurable range is 10% of the full scale.

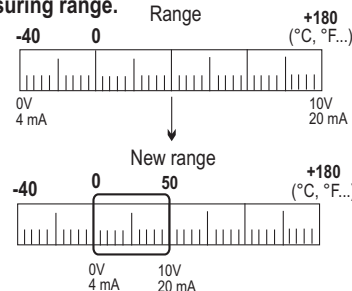

www.kimo.fr

Distributed by :

Calibration

Site calibration :

The EHK 500 is a reference portable instrument which enables you to adjust one point TH 200 and TH 300, by correcting any offset whilst measuring in a single ambient environment, housing both sensing elements. You can also adjust at several points.



Output diagnostics :

With this function, you can check with a multimeter (or a regulator/display, or a PLC/BMS) if the transmitter outputs work properly. The transmitter generates a voltage of 0 V, 5 V and 10 V or a current of 4 V, 12 V and 20 mA.



Certificate :

- Class 300 transmitters are supplied with adjusting certificates. Calibration certificates are offered as an option.
- Smart-Pro humidity probes are supplied with adjusting certificates and can also be supplied with calibration certificates offered as an option.

Mounting

To install the transmitter on a wall : fix the stainless steel plate to the wall (this plate is supplied with the transmitter).

Drill 8mm holes and mount the plate with the screws and wall-plugs supplied with the transmitter. Insert the transmitter on the plate (see A on the drawing shown below), by aligning it at 30°. Rotate its housing in clockwise direction until you hear a "click" which confirms that the transmitter is correctly installed. Then, open the housing, lock the clamping system of the housing on the plate, with the screw as shown (to remove the transmitter from the plate, remember to remove the screw first).

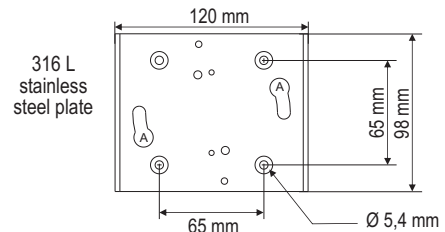
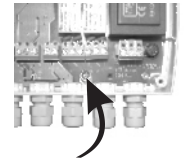

Maintenance

Avoid aggressive solvents. Protect the transmitter and probes from any cleaning product containing formol, which may be used for cleaning rooms or ducts.

Options

- RS 485 digital output for MODBUS protocol
- Configuration software LCC 300 with RS 232 cable
- Infrared remote control for configuration (for models with display)
- Calibration certificate.



Optional accessories

- Reference portable instrument EHK 500
- Wall-mounting plate for humidity remote probe
- Mounting brackets
- Sliding fittings
- Connection fittings
- Protection tips
- Caps for tips

